

記念品用
日本手ぬぐい〇〇枚
1色刷りor 2色刷り
カタログのイメージ
精密なイラストでなくてもよい
ブランド名を入れる

イメージ見本→

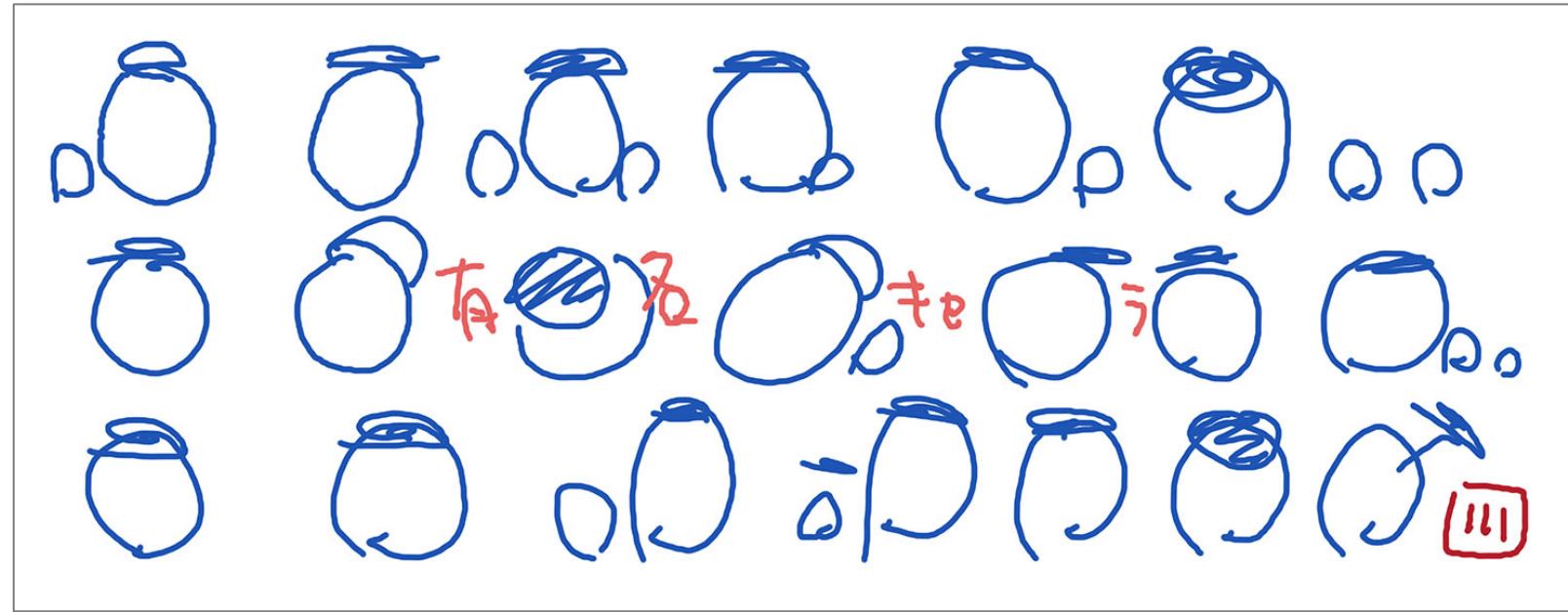

イラスト数、配置

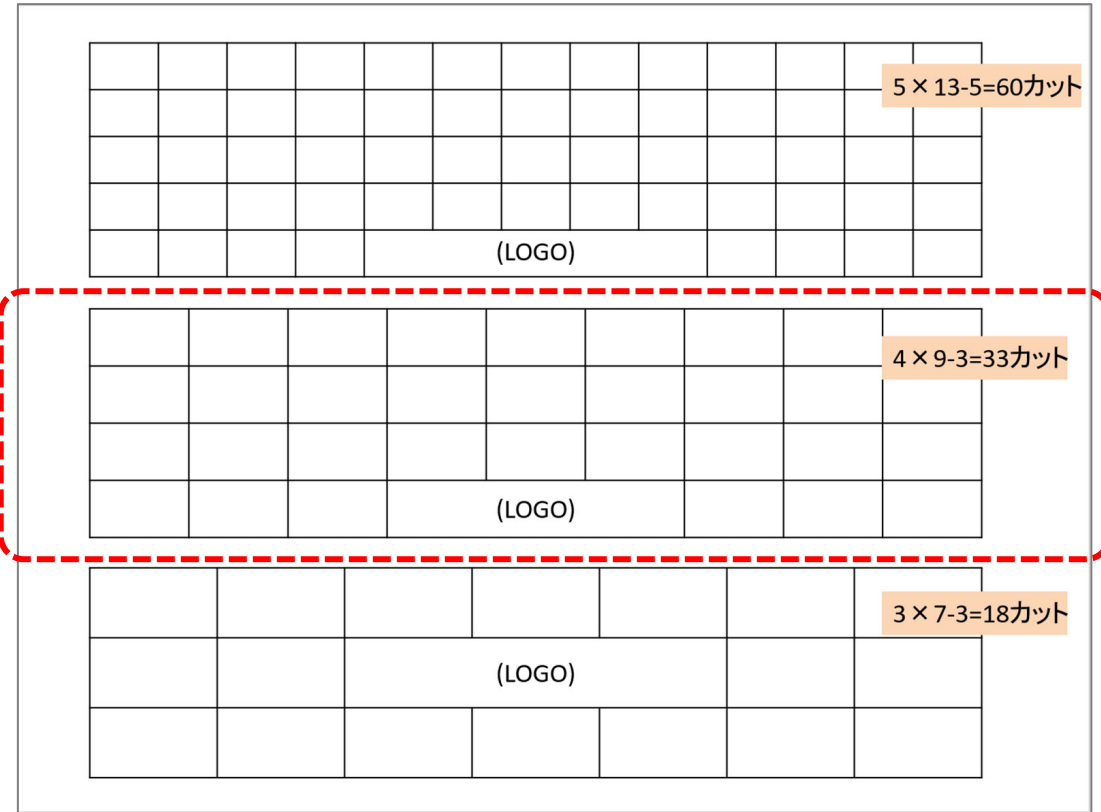

製品リスト作成、選択

品名	仕様	数量	単位	金額	備考
タオル	5x13	60	枚		
タオル	4x9	33	枚		
タオル	3x7	18	枚		

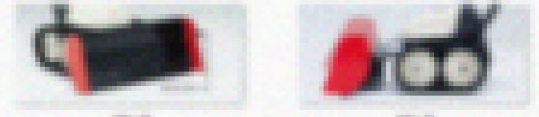
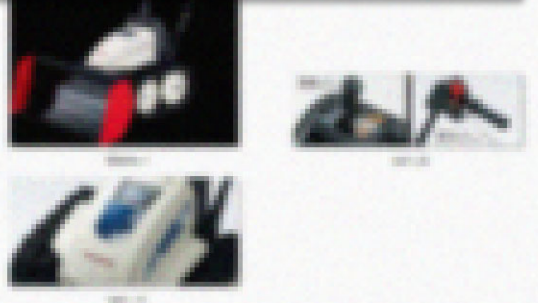
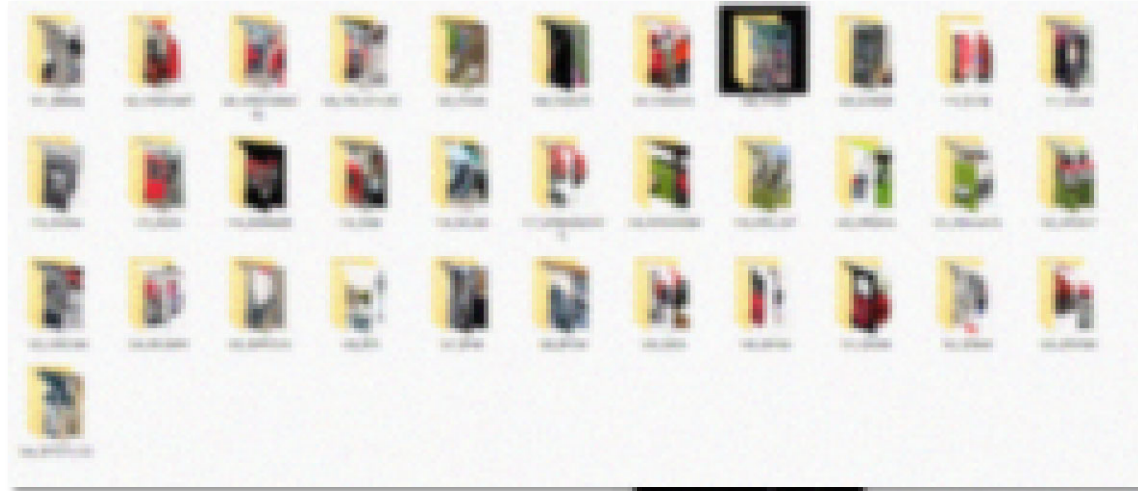

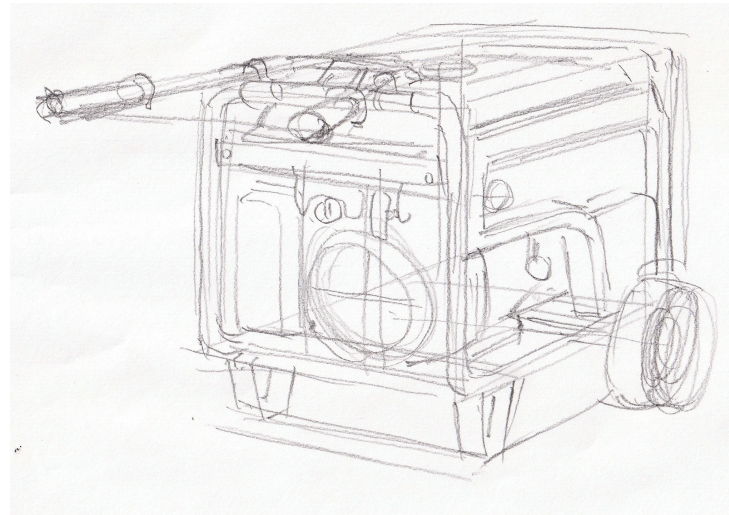
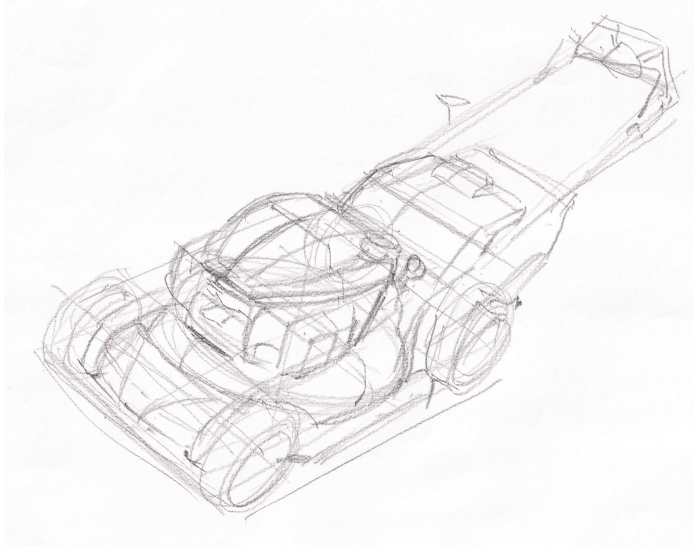
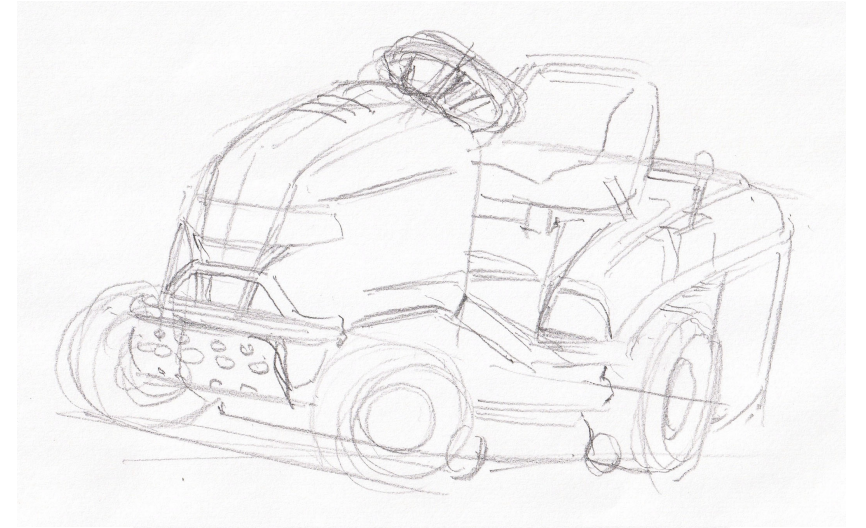
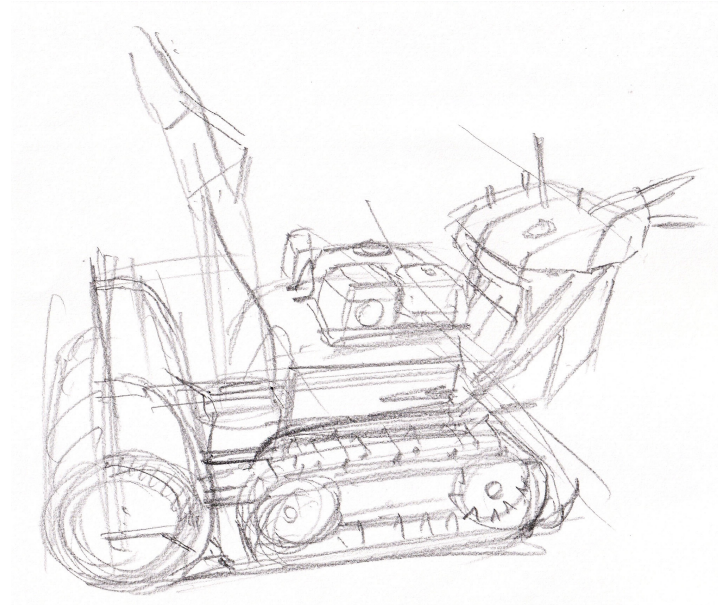
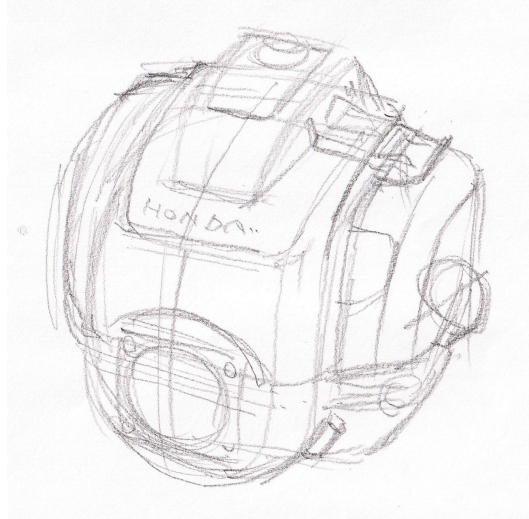

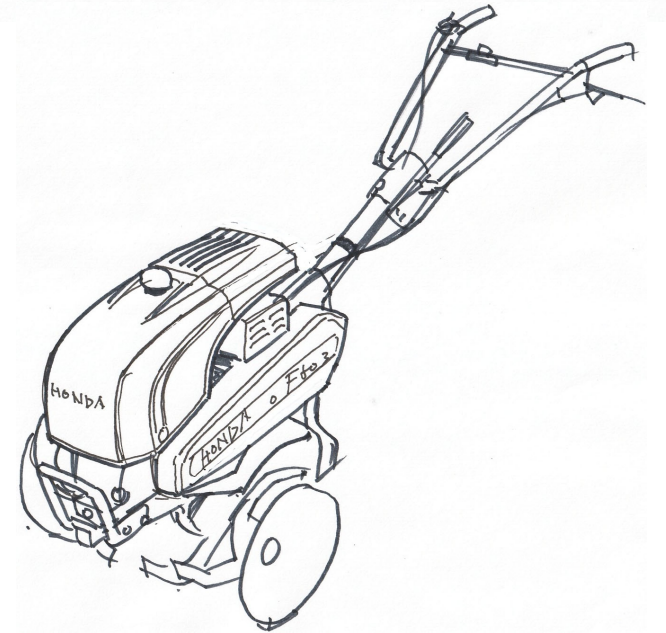
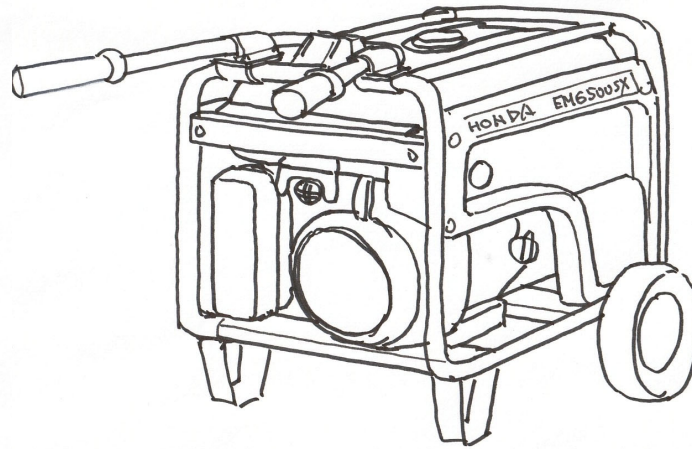
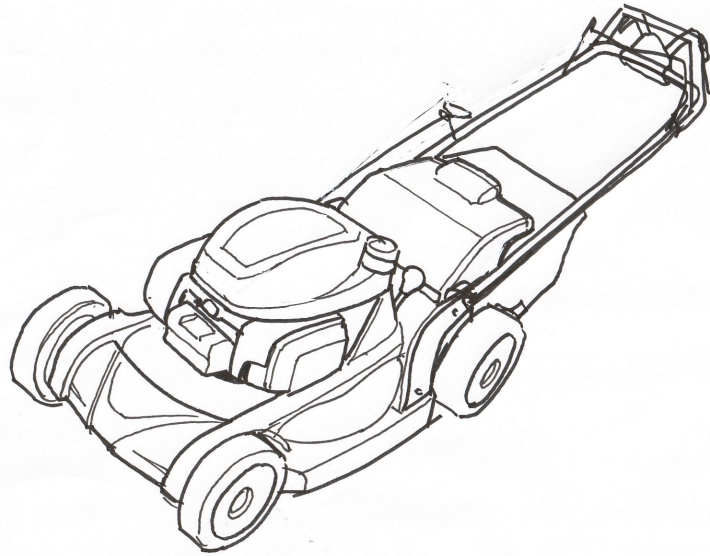
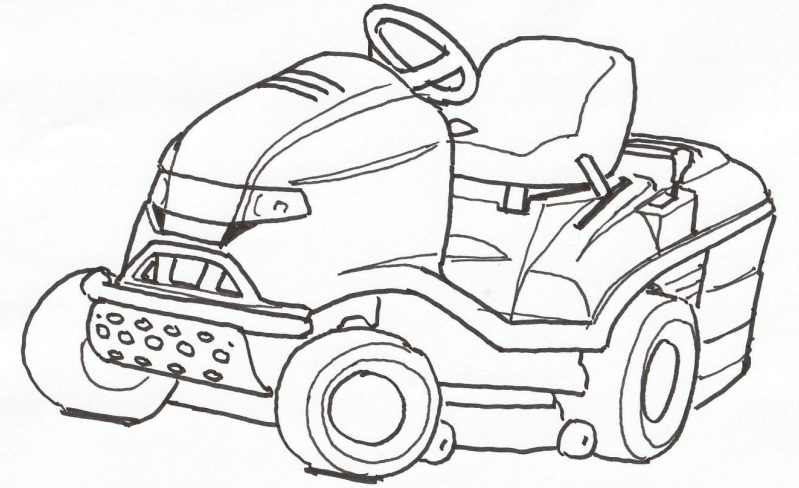
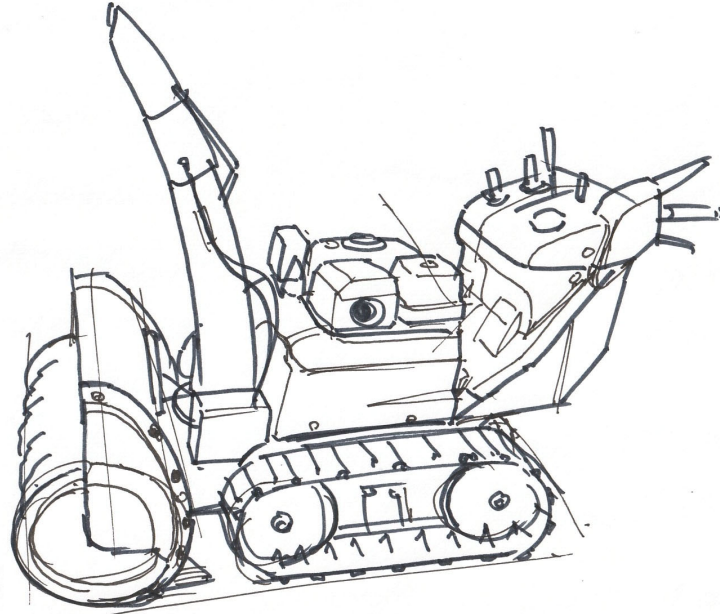
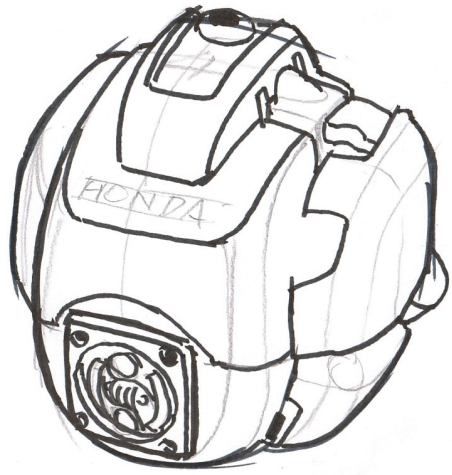

全体OK 2色刷りに決定

1色刷り

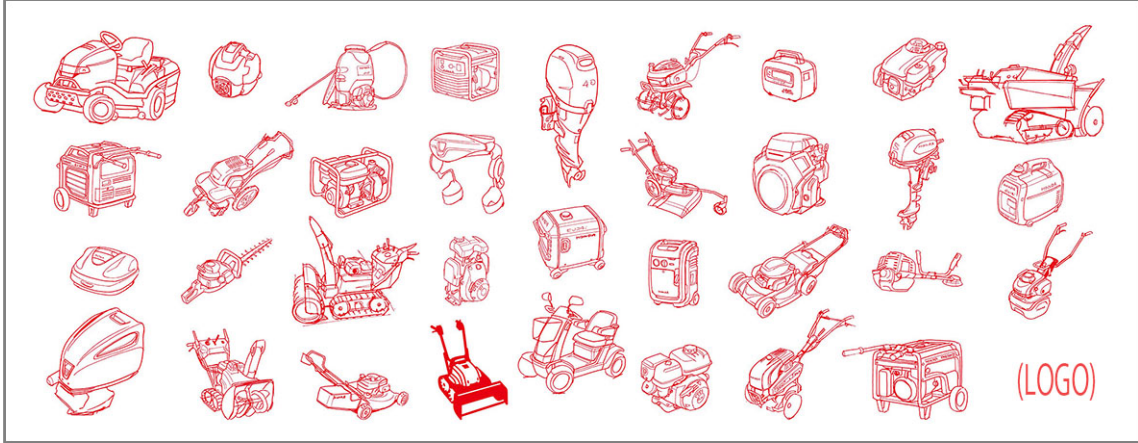

2色刷り

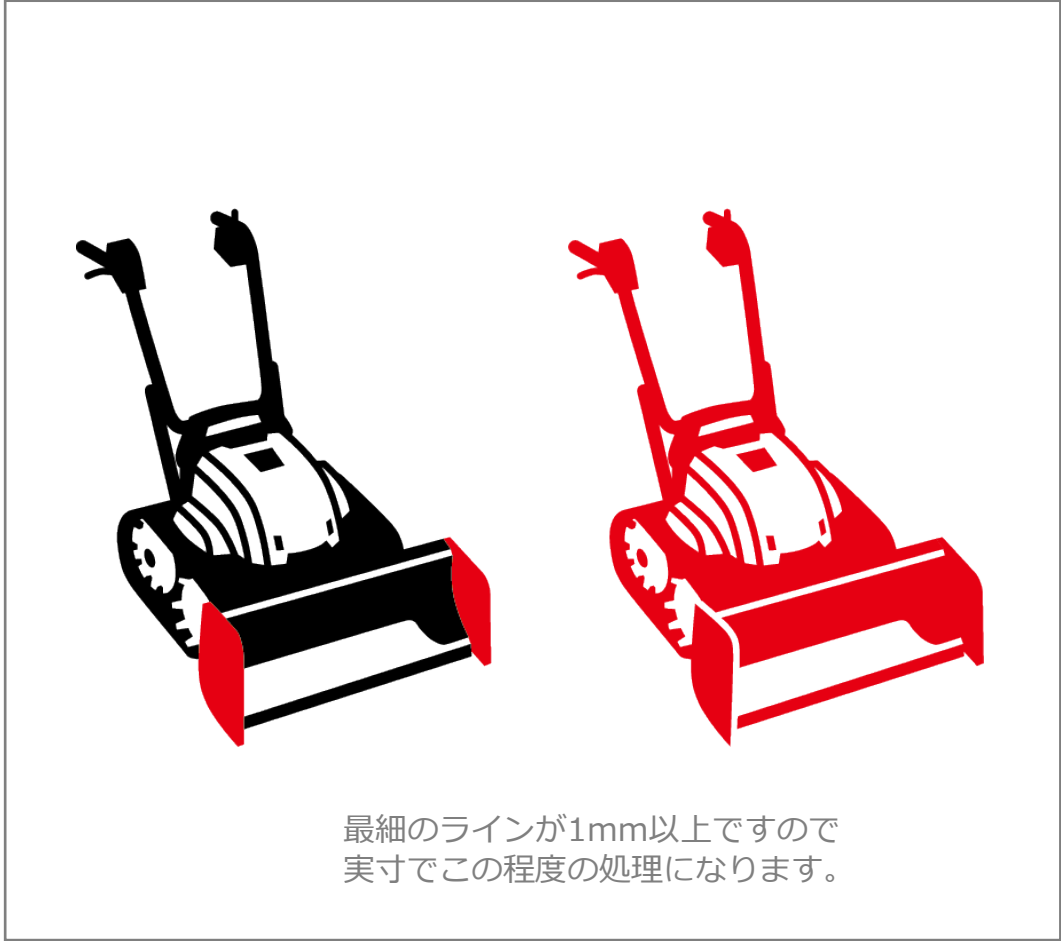
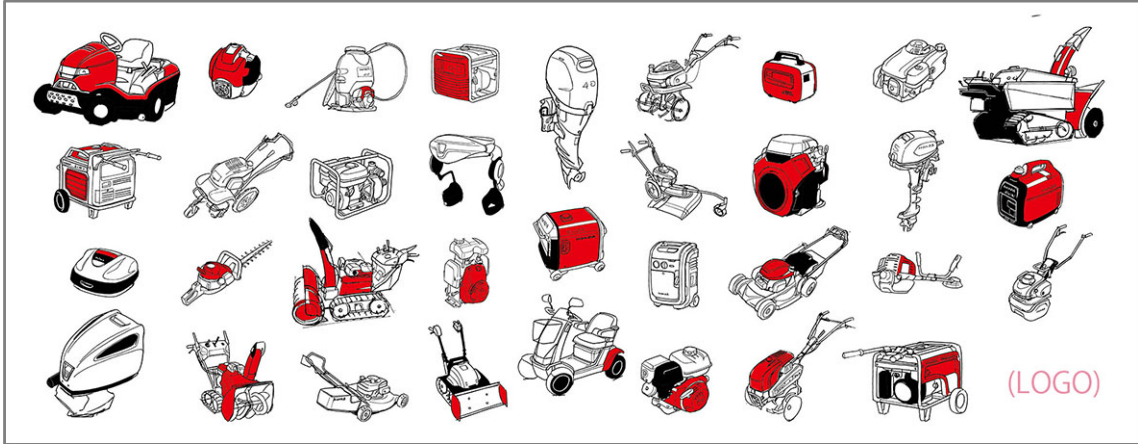

最細のラインが1mm以上ですので
実寸でこの程度の処理になります。

最小線幅1mm程度で調整

